

Sediment strainer (Type Y)

User's Manual



Thank you for choosing our product.

This User's Manual contains important information for safe use of our product, so please be sure to read it before handling the product. After reading this manual, please be sure to keep it in a place where the user can see it at any time.

ASAHI YUKIZAI CORPORATION

-SAFETY PRECAUTIONS-



This User's Manual is written on the assumption that the person who handles our products has a basic knowledge of our products, electrical equipment, machinery, control, etc., and it contains technical terms depending on the handling contents.

Please read this manual carefully and fully understand the contents and observe the safety precautions for proper use.

In this manual, the warning, caution, prohibition, and enforcement are categorized together with the symbol to inform the situation and scale of human injury or property damage.

Failure to observe this precaution may result in unexpected failure or damage. Be sure to observe this precaution.

<WARNING/CAUTION indications>

 Warning	Indicates a potentially hazardous situation which, if not avoided, could result in death or serious injury.
 Caution	Indicates a potentially hazardous situation which, if not avoided, may result in minor or moderate injury or property damage.

<Prohibited/Forced display>



 Prohibition	In the handling of the product, it is prohibited to do it in "Do not do it".
 Forcing	In the handling of the product, it is forced by "contents to be carried out without fail".

Table of contents

1. Our product warranty coverage	4
Applicable to	4
Warranty Period.....	4
Guaranteed range.....	4
Disclaimer.....	4
2. Safety Instructions	5
Unpacking, Transportation and Storage.....	5
Product Handling.....	6
3. Name of each part	8
4. Product Specifications	9
Model number table.....	9
Relationship between maximum allowable pressure and temperature	10
5. Piping method	11
Flanged end.....	12
Threaded end.....	14
Socket end.....	15
6. Disassembly and assembly procedure for parts replacement	17
7. Inspection item	19
Daily inspection	19
Periodic inspection.....	20
8. Cause of malfunction and remedy	21
9. Disposal method of residual materials and waste materials	21
Inquiries	22

1. Our product warranty coverage

Unless otherwise stated in the Contract or Specifications, etc., the warranty for the piping material products (hereinafter referred to as "applicable products") such as valves manufactured or sold by us is as follows.

Applicable to

This warranty applies only when the product is used in Japan. If you intend to use the product overseas, please contact us.

Warranty Period

The warranty period is one year after delivery.

Guaranteed range

In the event of failure or malfunction due to our responsibility during the above warranty period, we will replace or repair the product with a substitute free of charge.

Provided, however, that even within the warranty period, the warranty shall not apply to any of the following cases (charged service).



- ▶ When the storage, operating conditions, precautions, etc. described in the specifications, User's Manual, etc. are not adhered to in the construction, installation, handling, maintenance, etc.
- ▶ Defects, such as the design of the customer's equipment or software, caused by other than the target product.
- ▶ The fault is due to modification or secondary processing of the product by something other than us.
- ▶ In the case of a failure which can be deemed to have been avoided if the periodic inspection described in the User's Manual, etc. or the maintenance or replacement of consumable parts has been performed normally.
- ▶ The component is used for purposes other than the product's intended use.
- ▶ Failure or malfunction due to causes that could not be foreseen by our level of science and technology at the time of shipment.
- ▶ The fault is due to an external factor that is not our responsibility, such as natural disaster or disaster.



Disclaimer

- ▶ The warranty will not cover secondary damage (damage to equipment, loss of opportunity, loss of profit, etc.) or any other damage caused by the failure of our product.
- ▶ Although we strive to improve the quality and reliability of our products, we do not guarantee their integrity. Especially when using this product for equipment that may infringe human life, body or property, take appropriate safety design measures, etc., with full consideration of problems that may normally occur. We assume no responsibility for such use if we have not obtained our consent in advance in writing of specifications, etc.
- ▶ Please observe the product specifications and precautions when using our products. We shall not assume any responsibility for any damage to the customer caused by the customer's negligence. However, this does not apply to damage caused by a defect in our product.

2. Safety Instructions

Unpacking, Transportation and Storage

 Warning	
 Forcing	<p>Serious injury can result.</p> <ul style="list-style-type: none"> ▶ When hanging or slinging a valve, pay sufficient attention to safety, and do not enter under the load.

 Caution	
 Prohibition	<p>The valve can be damaged, or leak.</p> <ul style="list-style-type: none"> ▶ Do not subject the product to impact by throwing, dropping or hitting. ▶ Do not scratch or pierce the product with a sharp object such as a knife or hand hook. ▶ Do not pile up cardboard boxes forcefully to prevent the load from collapsing. ▶ Avoid contact with coal tar, creosote (a wood preservative), white pesticides, insecticides, paints, etc.
 Forcing	<p>The valve can be damaged, or leak.</p> <ul style="list-style-type: none"> ▶ Keep in cardboard until just before piping, and store indoors (at room temperature) away from direct sunlight. Also, avoid storing the product in places of high temperature. (The strength of cardboard packaging decreases when it gets wet. Be very careful when storing and handling it.) ▶ After unpacking, make sure that the product is correct and that it meets the specifications.

Product Handling

 **Warning**

 **Forcing**



Serious injury can result.

- ▶ If positive pressure gas is used for our resin piping material, a dangerous condition may be presumed due to the repulsive force peculiar to compressible fluid even if the pressure is the same as the water pressure. Therefore, be sure to take safety measures for the surrounding area, such as covering the piping with protective materials. If you have any questions, please contact us separately.
- ▶ When conducting a pipe leak test after completion of piping construction, be sure to check with water pressure. Contact us in advance if you are unavoidable to test with a gas.
- ▶ Care should be taken that vaporizable fluids such as hydrogen hydroxide (H₂O₂) and soda hypochlorite (NaClO) may cause an abnormal rise in pressure inside the strainer due to vaporization. (If the internal pressure rises abnormally due to vaporization, the gas is a compressible fluid, so in the unlikely event that the valve is damaged, it is very dangerous as the pieces may scatter and explode.)

The screen may be deformed or damaged.

- ▶ Use the product below the allowable flow speed shown in the table below.

Size (mm)	15	20	25	32	40	50	65	80	100
Max. allowable flow rate (m/sec)	5	5	5	3	3	3	2	2	1.5

 Caution	
 Prohibition	<p>The valve can be damaged, or leak.</p> <ul style="list-style-type: none"> ▶ Do not step on the valve or place heavy objects on it. ▶ Keep away from fire and hot objects.
 Forcing	<p>The valve can be damaged, or leak.</p> <ul style="list-style-type: none"> ▶ Keep the pressure and temperature of the fluid within the allowable range. (The maximum allowable pressure includes water hammer pressure.) ▶ Secure sufficient space for maintenance and inspection when piping. ▶ Use a valve of suitable material for the operating conditions. (Depending on the type of chemical liquid, the parts may be damaged. Contact us in advance for details.) ▶ Avoid any place where the valve is constantly exposed to splashes of water and dust, or direct sunlight, or protect the valve with a cover or the like to cover the entire area. ▶ Perform maintenance on a regular basis referring to "7. Inspection item." Pay particular attention to temperature changes and aging during long-term storage or shutdown or use. ▶ It is recommended to install a differential pressure gauge before and after the strainer in order to manage the screen clogging condition. In this case, maintain the screen using the differential pressure "0.1MPa" as a guide. ▶ The universal strainer (Y type) has a structure that is susceptible to repetitive stresses caused by internal pressure fluctuations at its corners. Lines that generate pulsation (including air hammer and water hammer) may cause damage. <p>Doing so may discolor the main unit or deform the screen and prevent it from functioning.</p> <ul style="list-style-type: none"> ▶ Pipe the product so that it is not exposed to direct sunlight.

3. Name of each part

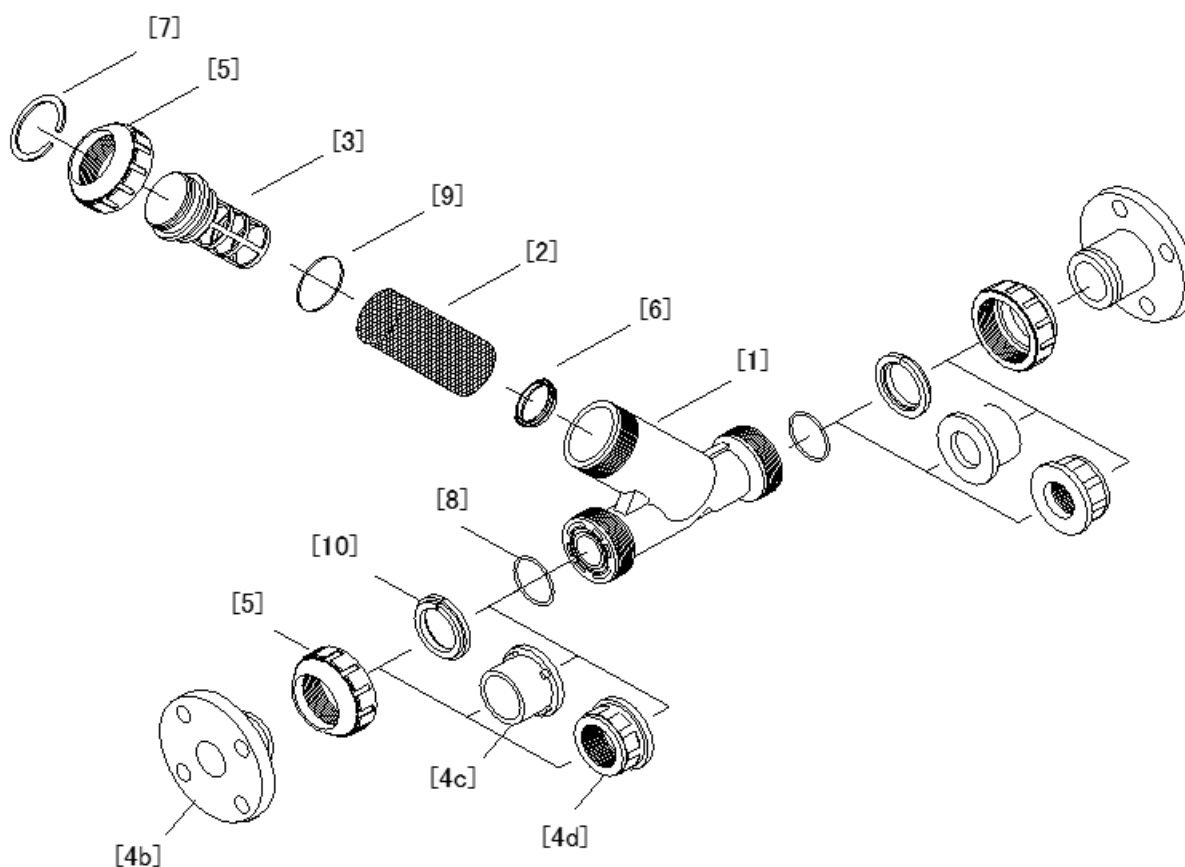

[1]	Body	[5]	Union nut
[2]	Screen	[6]	Retaining ring
[3]	Screen support	[7]	Split ring
[4b]	End connector (Flange end)	[8]	O-ring (A)
[4c]	End connector (Socket end)	[9]	O-ring (B)
[4d]	End connector (Threaded end)	[10]	Stop ring

4. Product Specifications

Model number table

Actuation	Type	Mesh size	Body material	Seal material	Connection	Standard	Size	High purity series
V	YS	**	U	*	*	*	***	*
V Manual valve	YS Y-Sediment strainer	2U 20 mesh	U U-PVC	E EPDM	S Socket	J JIS	015 15mm	- Non
		3U 30 mesh		V FKM	N Threaded	D DIN	020 20mm	1 Lubricant free
		4U 40 mesh			F Flanged	A ANSI	025 25mm	
		5U 50 mesh				1 JIS 10K	032 32mm	
		6U 60 mesh				5 JIS 5K	040 40mm	
							050 50mm	
							065 65mm	
							080 80mm	
							100 100mm	

Relationship between maximum allowable pressure and temperature

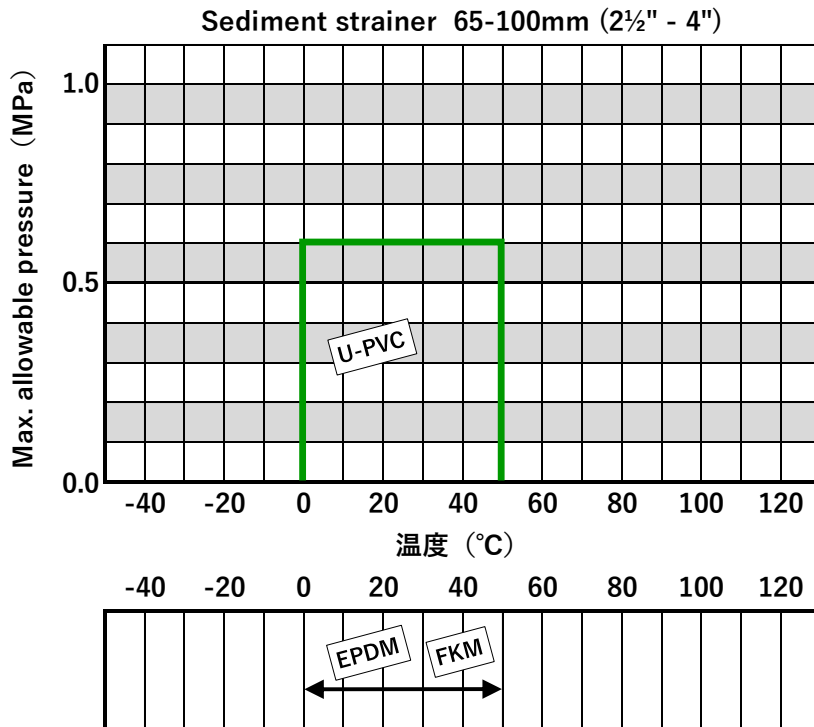
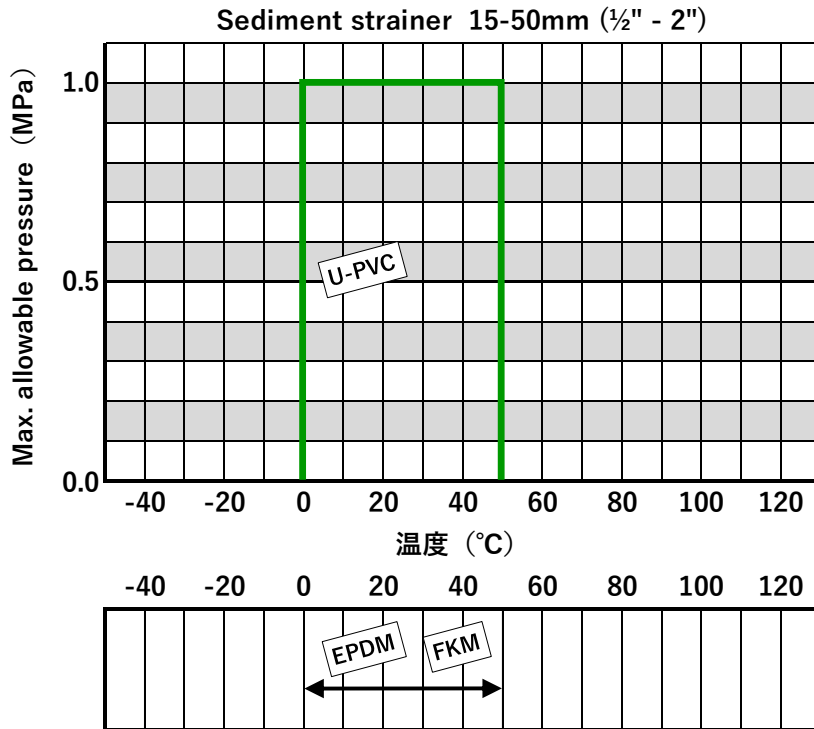

* This table shows the maximum allowable pressure of the strainer body, It does not indicate screen strength.

5. Piping method

Warning

Forcing

Serious injury can result.

- ▶ Be sure to perform safety inspections of the machine tool and power tool beforehand.
- ▶ When installing piping, be sure to wear the appropriate protective equipment according to the operation details.

Caution

Prohibition

The valve can be damaged, or leak.

- ▶ Be careful not to overtighten the pipe support when you remove it with a U band or the like.
- ▶ Do not overtighten the Union nut.
- ▶ Do not use a pipe wrench when tightening the Union nut.
- ▶ Pipe the product so that it is not exposed to direct sunlight. (The product may be discolored or the screen may be deformed and malfunction.)
- ▶ Fix the End connector during piping work or disassembly and reassembly.
- ▶ Be sure to check that the Union nut is fully tightened before the water flow test.
- ▶ Tighten the Union nut paying attention to the shaft center misalignment and face-to-face dimension.
- ▶ When connecting a resin valve to metal piping, be careful not to apply piping stress to the resin valve.

Forcing

The valve can be damaged, or leak.

- ▶ When installing the product, make sure that no excessive stress such as tension, compression, bending or impact is applied to the piping or valve, etc.
- ▶ Pay attention to the flow direction, and position the screen so that it faces downward in principle.
(The flow direction is indicated by an arrow on the body.)

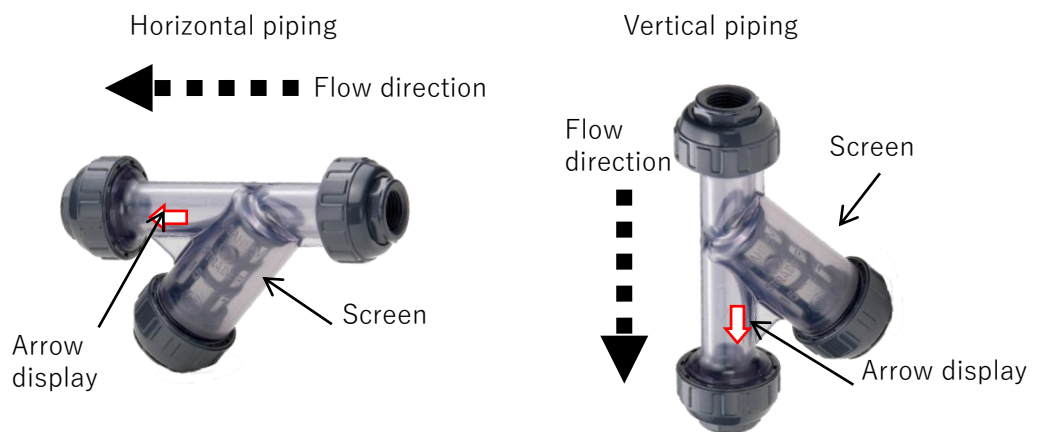

Flanged end

⚠ Caution

 Forcing	<p>The valve can be damaged, or leak.</p> <ul style="list-style-type: none"> ▶ Use a connection flange with a full-face seat. ▶ Check if the mutual flange standard is correct. ▶ Be sure to use sealing gaskets (AV Gasket), bolts, nuts and washers, and tighten them to the specified tightening torque. (The tightening torque will change if AV Gasket is not used.)
--	---

Preparations	▶ Torque Wrench	▶ Wrench	▶ Bolts, nuts, and washers
	▶ AV Gasket	▶ Belt Wrench	

[Procedure]

- 1) Set packing between flanges.
- 2) Insert the washer and bolt from the connecting flange side, insert the washer and nut from the valve side, and tighten temporarily by hand.

⚠ Caution

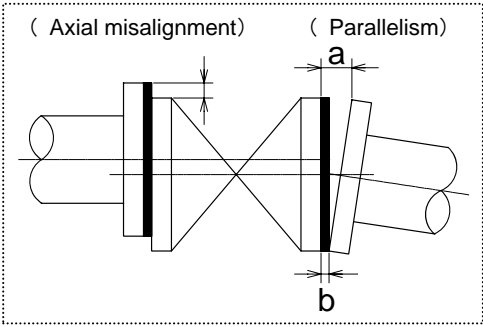
 Forcing	<p>The valve can be damaged, or leak.</p> <ul style="list-style-type: none"> ▶ Keep the parallelism of the flange surface and the dimension of shaft misalignment below the values shown below. 											
	<table border="1" style="width: 100%; border-collapse: collapse; text-align: center;"> <thead> <tr> <th>Size</th> <th>Shaft misalignment</th> <th>Parallelism (a-b)</th> </tr> </thead> <tbody> <tr> <td>15~32mm</td> <td>1.0mm</td> <td>0.5mm</td> </tr> <tr> <td>40~80mm</td> <td>1.0mm</td> <td>0.8mm</td> </tr> <tr> <td>100mm</td> <td>1.0mm</td> <td>1.0mm</td> </tr> </tbody> </table>		Size	Shaft misalignment	Parallelism (a-b)	15~32mm	1.0mm	0.5mm	40~80mm	1.0mm	0.8mm	100mm
Size	Shaft misalignment	Parallelism (a-b)										
15~32mm	1.0mm	0.5mm										
40~80mm	1.0mm	0.8mm										
100mm	1.0mm	1.0mm										

- 3) Gradually tighten to the specified torque value diagonally with a torque wrench. (Refer to Fig. 1.)
- 4) Tighten clockwise at least two turns at the specified torque value. (Refer to Fig. 1.)

⚠ Caution

! Forcing

The valve can be damaged, or leak.

▶ Do not tighten more than the specified torque value.

Flange tightening torque value

Units: N·m{kgf·cm}

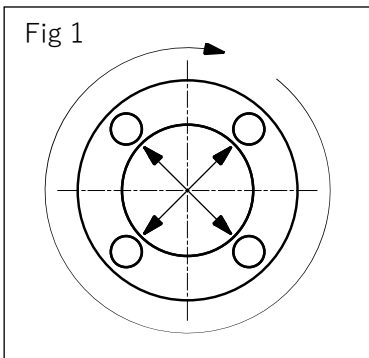

Size (mm)	15	20	25~40	50, 65	80, 100
PTFE coating	17.5	17.5	20.0	22.5	30.0
PVDF coating	{179}	{179}	{204}	{230}	{306}
Rubber	8.0 {82}	20.0 {204}	20.0 {204}	22.5 {230}	30.0 {306}



※If the Union nut is loosened or removed, attach it using the following method.

- 1) Check that O-ring (A) [8] is correctly fitted to the body.
- 2) Contact the End connector [4a] and the Union nut [5] to the body so that O-ring (A) [8] does not come off.
- 3) Tighten the Union nut [5] by hand until it is tight.
- 4) Screw the Union nut [5] by 1/4 to 1/2 turn with a belt wrench to avoid damage.

Threaded end

 Caution	
 Prohibition	<p>The valve can be damaged, or leak.</p> <ul style="list-style-type: none"> ▶ Do not overtighten the screws at the joints.
 Forcing	<p>The valve can be damaged, or leak.</p> <ul style="list-style-type: none"> ▶ The Union nut of this product is lightly tightened to make it easier to loosen. Be sure to remove the End connector before installation. ▶ Make sure that the screws at the joints are made of resin. ▶ Use sealing tape for the threaded joints of our resin piping materials. If liquid sealant or liquid gasket is used, stress cracking (environmental stress cracking) may occur.



Preparations ▶ Sealing tape ▶ Belt wrench ▶ wrench

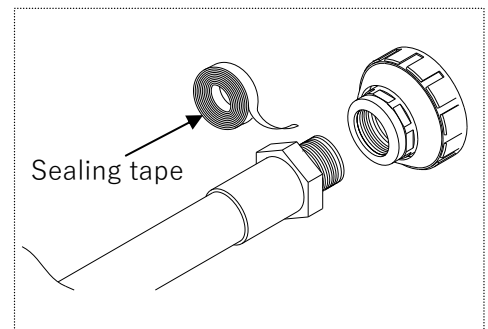

[Procedure]

- 1) Wrap sealing tape around the male thread of the fitting, leaving approximately 3mm at the end.
- 2) Loosen the Union nut [5] with a belt wrench.
- 3) Remove Union nut [5] and End connector [4c].
- 4) Tighten the male thread of the fitting and the End connector [4c] until they are tight by hand.
- 5) Screw on the End connector [4c] by 1/2 to 1 turn with a wrench to prevent scratching.
- 6) Check that O-ring (A) [8] is correctly fitted to the body.
- 7) Contact the End connector [4c] and Union nut [5] to the body so that the O-ring (A) [8] does not come off.
- 8) Tighten the Union nut [5] by hand until it is tight.
- 9) Screw the Union nut [5] 1/4 to 1/2 turn with a belt wrench to avoid damage.



Socket end

 Warning	
 Prohibition	<p>Serious injury can result.</p> <ul style="list-style-type: none"> ▶ When using adhesives, ventilate thoroughly, and prohibit the use of open flames in the surroundings. Do not inhale odors directly.
 Forcing	<p>Serious injury can result.</p> <ul style="list-style-type: none"> ▶ If the adhesive adheres to the skin, remove it immediately. In addition, if you feel worse or feel abnormal, promptly seek a doctor's diagnosis and take appropriate action. <p>Solvent cracks may occur, resulting in damage.</p> <ul style="list-style-type: none"> ▶ Be careful when constructing under low temperature, as solvent vapor is less likely to evaporate and tends to remain. <p>After piping, open both ends of the pipe and use a blower (low-pressure type) to ventilate to remove the solvent vapor.</p>

 Caution	
 Prohibition	<p>Solvent cracks may occur, resulting in damage.</p> <ul style="list-style-type: none"> ▶ Do not apply more adhesive than is necessary. <p>The valve can be damaged, or leak.</p> <ul style="list-style-type: none"> ▶ Do not under any circumstances insert the pipe by striking or hammering it into the end connector.
 Forcing	<p>The valve can be damaged, or leak.</p> <ul style="list-style-type: none"> ▶ The Union nut of this product is lightly tightened to make it easier to loosen. Be sure to remove the End connector before installation. ▶ Use ASAHI AV Cement for the adhesive. (Select an ASAHI AV Cement according to the material.) ▶ Perform the water flow test after at least 24 hours have elapsed after completion of bonding.

Preparations ▶ AV Cement ▶ Belt Wrench

[Procedure]

- 1) Loosen the Union nut [5] with a belt wrench.
- 2) Remove Union nut [5] and End connector [4b].
- 3) Pass the Union nut [5] to the pipe side.
- 4) Wipe off the socket part of the End connector [4b] with a waste cloth.
- 5) End connector [4b] Apply adhesive evenly to the socket and pipe socket.



Amount of adhesive used (reference)

Size (mm)	15	20	25	32	40	50	65	80	100
Amount used (g)	1.0	1.3	2.0	2.4	3.5	4.8	6.9	9.0	13.0

- 6) After applying the adhesive, quickly insert the pipe into the End connector [4b] and hold for at least 60 seconds.
- 7) Wipe off any excess adhesive.
- 8) Check that O-ring (A) [8] is correctly fitted to the body.
- 9) Contact the End connector [4b] and Union nut [5] to the body so that the O-ring (A) [8] does not come off.
- 10) Tighten the Union nut [5] by hand until it is tight.
- 11) Screw the Union nut [5] by 1/4 to 1/2 turn with a belt wrench to avoid damage.

6. Disassembly and assembly procedure for parts replacement

⚠ Caution	
⊘ Prohibition	<p>The valve can be damaged, or leak.</p> <ul style="list-style-type: none"> ▶ Do not overtighten the Union nut. ▶ Do not use a pipe wrench when tightening the Union nut.
! Forcing	<p>There is a risk of injury.</p> <ul style="list-style-type: none"> ▶ Be sure to perform safety inspections of the machine tool beforehand. ▶ Wear appropriate protective equipment according to the type of work being performed. ▶ Reduce the fluid pressure in the piping to zero and drain the fluid from the strainer. ▶ Fluid remains inside the strainer body and screen assembly even after the piping has been drained. Residual fluid will be discharged when the strainer is disassembled. Prepare a suitable container to collect the discharged fluid and take appropriate measures to prevent leakage. ▶ The split ring will pop out when you remove it, so please remove it inside a plastic bag. <p>The screen can be damaged.</p> <ul style="list-style-type: none"> ▶ Handle the screen carefully and clean it regularly.

Preparations	<ul style="list-style-type: none"> ▶ Belt wrench ▶ Protective gloves ▶ Protective glasses ▶ Receiving tray ▶ Plastic bag
--------------	---

Disassembly and cleaning

[Procedure]

- 1) Loosen Union nut [5] and remove screen assembly ([2], [3], [5], [6], [7], and [9]) from body [1].
- 2) Remove the Retaining ring [6] and take out the screen [2].
- 3) Wash screen [2] in water to remove debris, dirt and other foreign matter. If damaged, replace it with a new one.
- 4) Place the screen assembly in a plastic bag, remove the split ring [7] from the screen support [3], and remove the union nut [5].
- 5) Remove the O-ring (B) [9] attached to the screen support [3]. Replace it with a new one if it is damaged.

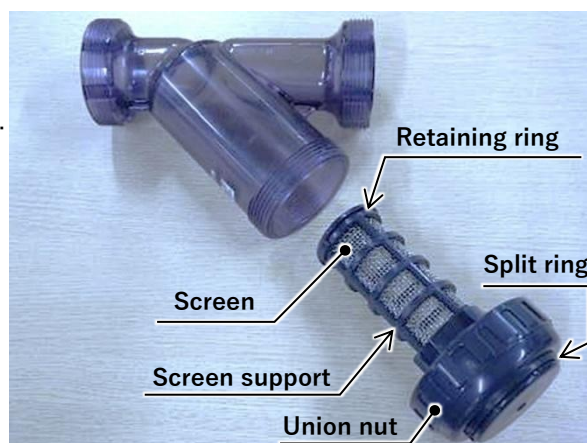

Assembly**[Procedure]**

- 1) Attach the O-ring (B) [9] to the screen support [3].
- 2) Attach the screen [2] to the screen support [3] and attach the retaining ring [6].
- 3) Insert the assembled screen assembly ([2], [3], [6], and [9]) into the body.
- 4) Screw in the union nut [5] and attach the split ring [7] to secure it.

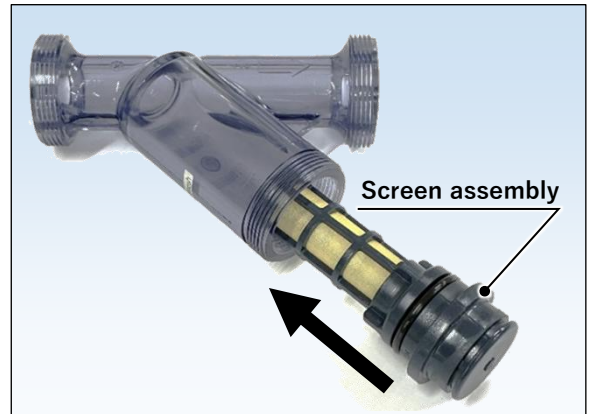

7. Inspection item

Caution

Forcing	<p>The valve can be damaged, or leak.</p> <ul style="list-style-type: none"> ▶ Maintenance should be performed every 3 to 6 months as a guide in order to keep the watch in normal condition and use it for a long time. Pay particular attention to temperature changes and aging during long-term storage or shutdown or use. ▶ When removing the valve from the piping when replacing the valve or parts, completely remove the fluid from the piping before starting work. ▶ If any trouble is found, take the appropriate action referring to "8. Cause of malfunction and remedy".
----------------	---

Daily inspection

Inspection items and inspection methods	Guideline of judgment	Check point	Treatment method
External leakage (visual inspection)	No leakage	[Flange end] Pipe flange connection	① Retighten the pipe bolts to the specified torque. ② Remove the valve from the pipe and retighten the pipe bolts. (Ref: 5 Piping method [Flange end])
		[Socket end] Adhesive construction section	Remove the valve from the piping and retry the bonding process. (Ref: 5 Piping method [Socket end])
		[Threaded end] Threaded connection	Remove the valve from the piping and screw the valve in again. (Ref: 5 Piping method [Threaded end])
		Union nut portion of the valve	① Retighten the Union nut ② Remove the valve from the piping, check the O-ring and sealing surface, and replace the defective part. (Ref.: 5. Piping method)
		Surface of the entire valve	Remove the valve from the pipe and replace the valve. (Ref.: 5. Piping method)
Abnormal noise (hearing)	No abnormal noise	Valve	Remove the valve from the pipe and replace the valve. (Ref.: 5. Piping method)
		Piping around the valve	Reconfirm the conditions of use (Ref: 2. Safety Instructions)

Periodic inspection

●Guideline for the inspection cycle: 3 months



Inspection items and inspection methods	Guideline of judgment	Check point	Remedy for malfunctions
Vibration (palpation)	No difference from other parts	Valve	Recheck the operating conditions and remove the source of vibration. (Ref: 2. Safety Instructions)
			Remove the valve from the pipe and replace the valve. (Ref.: 5. Piping method)
		Piping around the valve	Recheck the operating conditions and remove the source of vibration. (Ref: 2. Safety Instructions)

Periodic inspection

●Guideline of the inspection cycle: 6 months

Inspection items and inspection methods	Guideline of judgment	Check point	Remedy for malfunctions
Looseness of bolts (visual and palpation)	No Loose	[Flange end] For flange piping	Retighten the pipe bolts to the specified torque. (Ref: 5 Piping method [Flange end])
Product damage	No scratches, cracks, or deformation	Appearance of the product	Remove the valve from the pipe and replace the valve. (Ref.: 5. Piping method)

8. Cause of malfunction and remedy

 Warning	
 Forcing	<p>There is a danger of injury.</p> <ul style="list-style-type: none"> ▶ If any malfunction is found, immediately stop using the product and take appropriate action. ▶ When removing the valve from the piping when replacing the valve or parts, completely remove the fluid from the piping before starting work.

Failure phenomenon	Possible cause	Measures and measures
Fluid leaks from valve (external leak)	Union nut is loose	Retighten the Union nut (Ref.: 5. Piping method)
	O-ring is scratched, worn, melted, or altered	Stop using the product immediately, remove the valve from the piping, replace the relevant part, or replace the valve. (Ref.: 5. Piping method) (Ref.: 6. Disassembly and assembly procedure for parts replacement)
	Scratches or wear are found on the sliding or fixing surfaces of the O-ring.	Stop using the product immediately, remove the valve from the piping, replace the relevant part, or replace the valve. (Ref.: 5. Piping method) (Ref.: 6. Disassembly and assembly procedure for parts replacement)
	Valve is cracked or broken	Stop using the product immediately, remove the valve from the piping, and replace the valve. (Ref.: 5. Piping method)
Valve is corroded or deformed	The watch is exposed to water, chemical liquids, or other liquids.	Stop using the product immediately, remove the valve from the piping, and replace the valve. (Ref.: 5. Piping method)

9. Disposal method of residual materials and waste materials

 Warning	
 Forcing	<p>When burnt, toxic gas is generated.</p> <ul style="list-style-type: none"> ▶ When disposing of the product or parts, please dispose of them according to the guidelines of each local authority by a professional disposal company.

Inquiries

Contact the nearest dealer, our sales office, or our web website for inquiries about this product.

[User's Manual]

Sediment strainer (Type Y)



The product names, logos, and other trademarks mentioned in this instruction manual are all registered trademarks of ASAHI YUKIZAI CORPORATION.

These trademarks are the intellectual property of ASAHI YUKIZAI CORPORATION and may not be used without permission.

Nothing in this manual grants a license to use the trademarks, either expressly or implicitly.

For further details regarding registered trademarks, please contact ASAHI YUKIZAI CORPORATION.

<https://www.asahi-yukizai.co.jp/en>

Please note that the content of this manual is subject to change without notice.

June 2026

[User's Manual] Sediment strainer (Type Y)